

Features

- Ergonomic lever handle is ADA-compliant.

Installation

- Patented K-joint installation technology ensures consistent trim appearance, regardless of variability in valve rough-in.
- Wall-mount.
- Trim only; requires valve to complete installation (sold separately).

Required Products/Accessories

K-728-K 3/4" Two- or Three-Way Transfer Valve

Recommended Products/Accessories

K-23723 Faucet cleaner

ADA

CSA B651

OBC

Codes/Standards

ASME A112.18.1/CSA B125.1

ADA

ICC/ANSI A117.1

CSA B651







OBC

KOHLER® Faucet Lifetime Limited Warranty

See website for detailed warranty information.

Available Colors/Finishes

Color tiles intended for reference only.

Color	Code	Description
	CP	Polished Chrome
	PB	Vibrant® Polished Brass
	BN	Vibrant® Brushed Nickel
	BV	Vibrant® Brushed Bronze
	BRZ	Oil-Rubbed Bronze
	2BZ	Oil-Rubbed Bronze

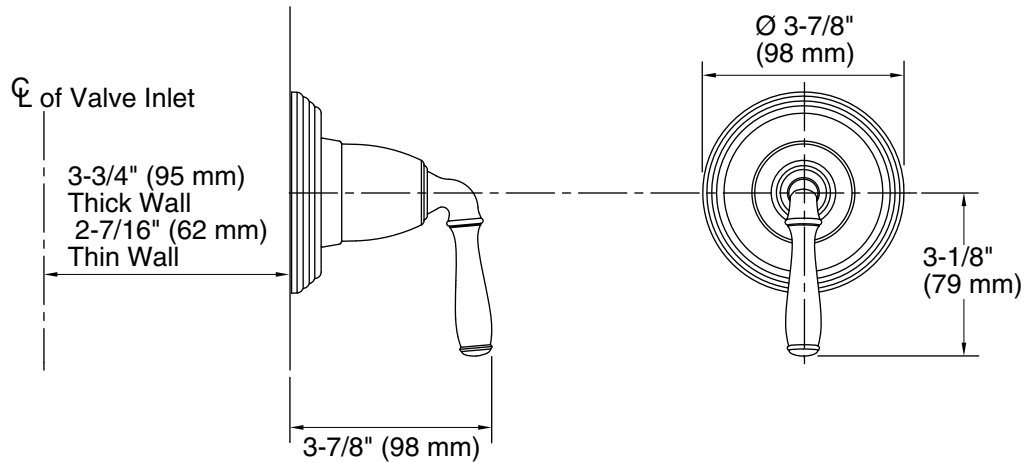

Technical Information

All product dimensions are nominal.

Notes

Install this product according to the installation guide.

ADA, OBC, CSA B651 compliant when installed to the specific requirements of these regulations.