



Bakersfield™

Top-mount Kitchen Sink
K-5832-3

Features

- 33-inch minimum base cabinet width.
- Single bowl.
- 8" Basin depth.
- Three faucet holes.

Material

- KOHLER® enameled cast iron.

Installation

- Top-mount.

Recommended Products/Accessories

- K-6517 Sink Rack
- K-8801 Sink Strainer
- K-8799 Sink Strainer
- K-23726 Drain treatment
- K-23725 Cast iron cleaner

Optional Products/Accessories

- K-5836 Cutting Board
- K-11352 Disposal Flange with Stopper
- K-9000 P-Trap



Codes/Standards









ASME A112.19.1/CSA B45.2

KOHLER® Enameled Cast Iron Kitchen Sink Lifetime Limited Warranty

See website for detailed warranty information.

Available Colors/Finishes

Color tiles intended for reference only.

Color	Code	Description
	0	White
	96	Biscuit
	47	Almond
	95	Ice™ Grey
	G9	Sandbar
	33	Mexican Sand™
	30	Iron Cobalt
	7	Black Black™

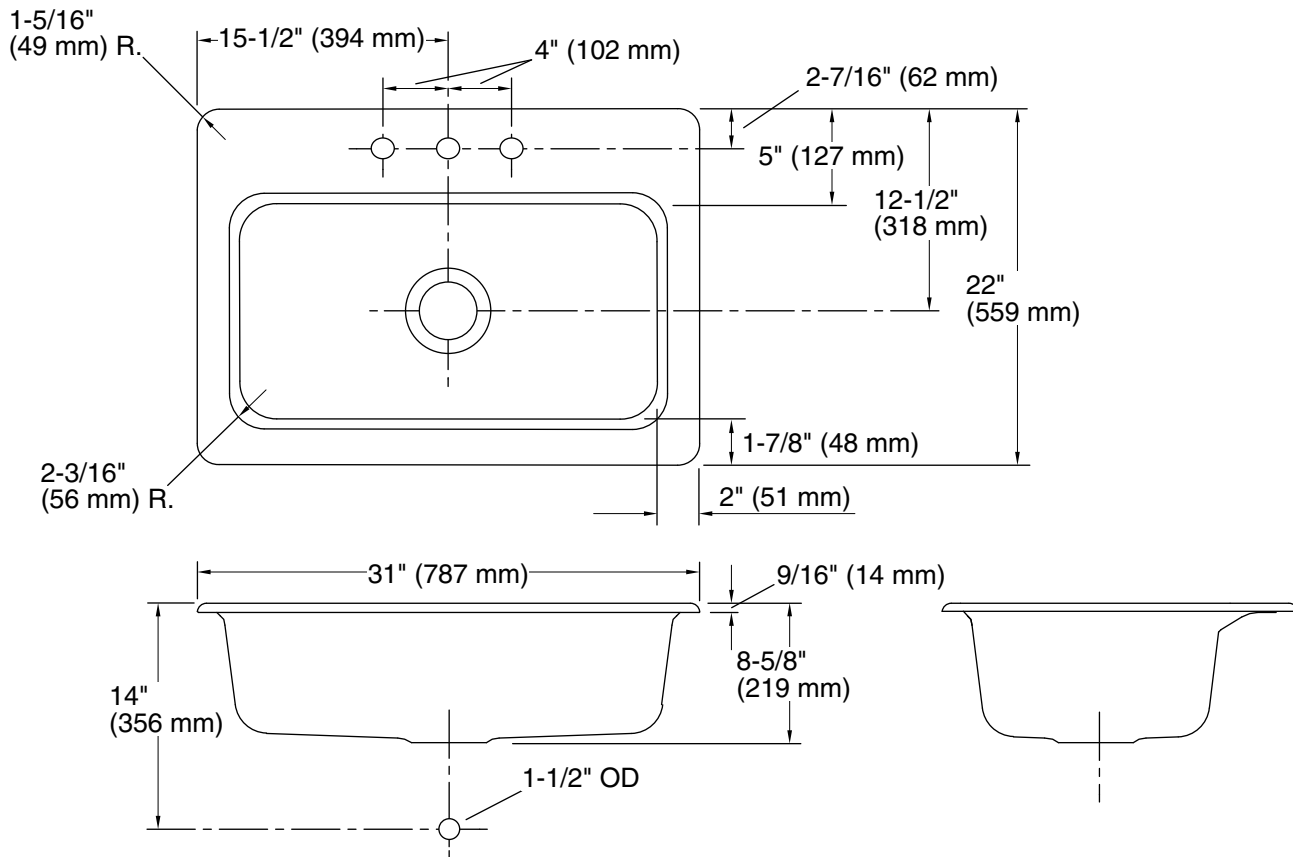

Technical Information

All product dimensions are nominal.

Bowl configuration:	Single
Installation:	Top-mount
Cutout:	Top-mount, 29-3/4" x 20-3/4" (756 mm x 527 mm) with 1" (25 mm) radius corners
Min. base cabinet width:	33" (838 mm)
Bowl area (Only):	Length: 27" (686 mm) Width: 15" (381 mm) Bowl depth: 8" (203 mm)
Number of deck holes:	3
Faucet hole(s):	1-3/8" (35 mm)
Drain hole:	3-5/8" (92 mm)

Notes

Install this product according to the installation instructions.

Cut-out is 29-3/4" (756 mm) by 20-3/4" (527 mm) with 1" (25 mm) radius corners.