

## Features

- Transitional styling
- Integrated air gap offers reverse osmosis (RO) compatibility
- Right-side lever handle
- 9-5/8" (244 mm) spout height
- 5-9/16" (141 mm) spout reach
- Faucet spout rotates 360° and offers clearance for filling glasses and pitchers
- 1.5 gpm (5.7 lpm) maximum flow rate at 60 psi (4.14 bar)
- Works with KOHLER® filtration systems or with other select filtration systems as a cold-water tap
- KOHLER® ceramic disc valves exceed industry longevity standards for a lifetime of durable performance

## Material

- Premium metal construction
- KOHLER® finishes resist corrosion and tarnishing

## Installation

- Single hole

## Recommended Products/Accessories

K-22155 Reverse osmosis (RO) water filtration system  
K-23723 Faucet cleaner

## Optional Products/Accessories

K-77686 Double-cartridge water filtration system  
K-29638 Two-stage water filtration system  
K-77685 Single-cartridge water filtration system



**ADA**

**CSA B651**

## Codes/Standards

ASME A112.18.1/CSA B125.1

NSF/ANSI/CAN 61

NSF/ANSI/CAN 372

All applicable US Federal and State material regulations

DOE - Energy Policy Act 1992

California Energy Commission (CEC)

ADA

ICC/ANSI A117.1

CSA B651







IAPMO Certification

## KOHLER® Faucet Lifetime Limited Warranty

See website for detailed warranty information.

## Available Colors/Finishes

*Color tiles intended for reference only.*

Color	Code	Description
	CP	Polished Chrome
	SN	Vibrant® Polished Nickel
	AF	Vibrant® French Gold
	VS	Vibrant® Stainless
	BV	Vibrant® Brushed Bronze
	BL	Matte Black
	2MB	Vibrant® Brushed Moderne Brass
	TT	Vibrant Titanium

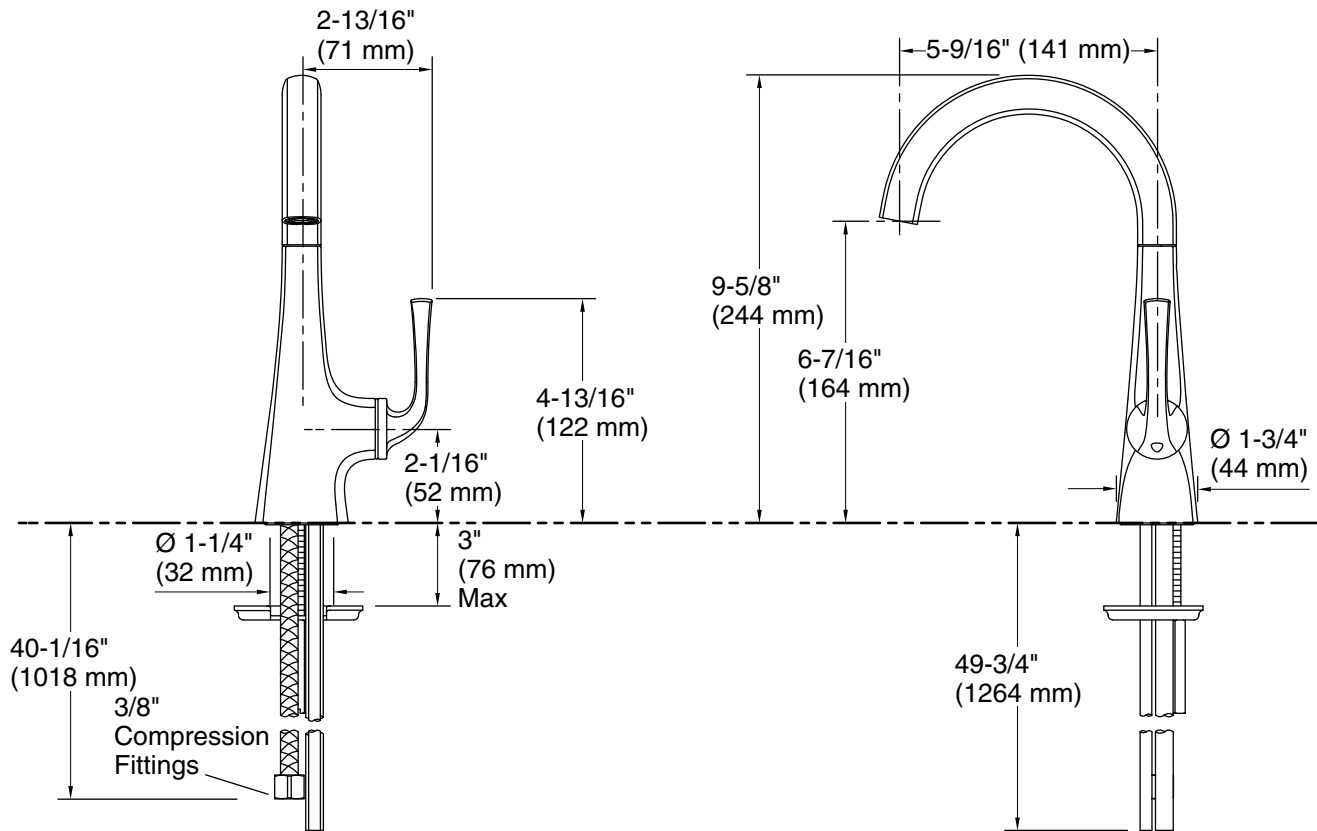

## Technical Information

All product dimensions are nominal.

### Faucet:

Flow rate: 1.5 gal/min (5.7 l/min)

Drain included: No

### Spout:

Spout reach: 2-13/16" (71 mm)

## Notes

Install this product according to the installation instructions.

ADA compliant for faucet handles only

ADA, CSA B651 compliant when installed to the specific requirements of these regulations.