

Features

- No faucet holes; requires wall- or counter-mount faucet.

Material

- Vitreous china.

Installation

- Vessel or wall-mount.
- Requires K-9655 Vessel bracket for wall-mount installation.

Recommended Products/Accessories

K-7114 Pop-Up Drain
K-7129 Drain
K-9018 P-Trap
K-9655 Wall-Mount Vessel Bracket

Included Components

Additional Components:
Adjustable linkage



ADA CSA B651

Codes/Standards













ASME A112.19.2/CSA B45.1
ADA
ICC/ANSI A117.1
CSA B651

KOHLER® One-Year Limited Warranty

See website for detailed warranty information.

Available Colors/Finishes

Color tiles intended for reference only.

Color	Code	Description
	0	White
	HW1	Honed White
	96	Biscuit
	47	Almond
	NY	Dune
	95	Ice™ Grey
	G9	Sandbar
	K4	Cashmere
	58	Thunder™ Grey
	7	Black Black™
	HW	Bouclé™ Muslin
	HV	Bouclé™ Tweed

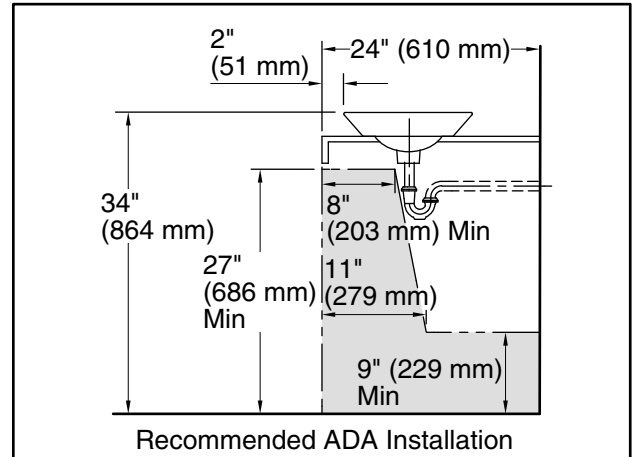
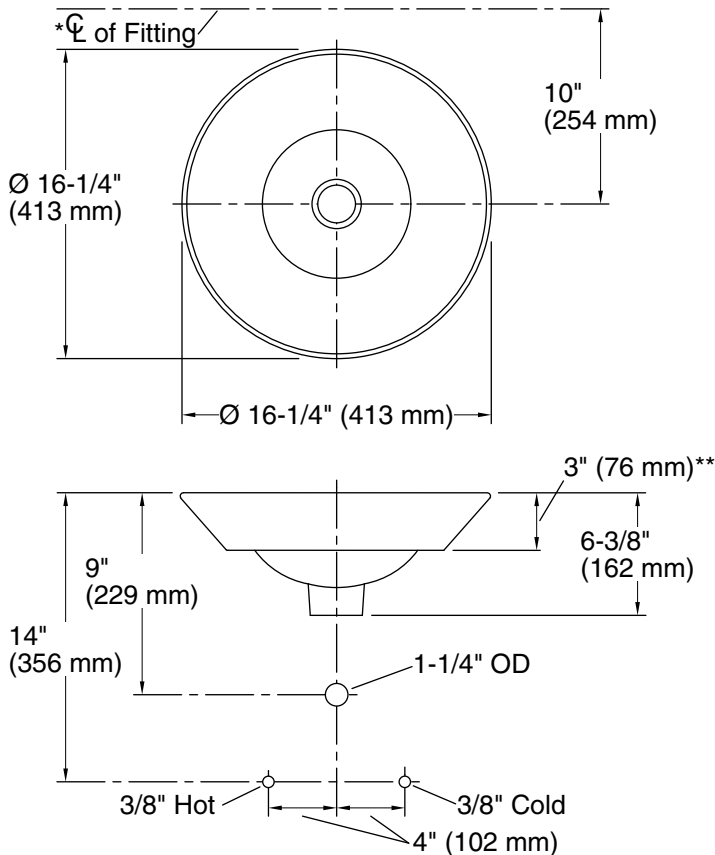

Technical Information

All product dimensions are nominal.

Bowl configuration:	Single
Installation:	Vessel, Wall-mount
Bowl area (Only):	Diameter: 15-7/8" (403 mm) Water depth: 4-1/4" (108 mm)
Drain hole:	1-3/4" (44 mm)
Template:	1002980-7, required, included

Notes

Install this product according to the installation instructions.

Product does not have an overflow.

*Spout must be 5" (127 mm) long (min) for adequate clearance into the bathroom sink when installed with centerline as shown.

NOTICE: Countertop manufacturer or cutter must use the cut-out template provided with the product, or a current one provided by Kohler Co. (call 1-800-4-KOHLER). Kohler Co. is not responsible for cutout errors when the incorrect cut-out template is used.

ADA, CSA B651 compliant when installed to the specific requirements of these regulations.