

NOTE: before cutting countertop
Allow for handle clearance
注意：在切割台面之前，请留出
安装龙头的空间。

FINISHED WALL / BACK SPLASH
完工墙面/防溅挡板

NOTE: Using this template, the
overhung is about 6mm. Customers
can zoom the template by scale to
meet their requirement.

注意：采用此切割模板切割的台面内沿
到面盆内边缘的距离为6mm左右，客户
可根据需要按比例缩放用以切割台面。

CENTERLINE OF FITTING
安装中线

KOHLER

SQUARE UNDER-COUNTER LAVATORY 方形台下盆 CUT-OUT TEMPLATE / INSTALLATION INSTRUCTIONS 切割图/安装说明书

BEFORE YOU BEGIN

- Due to the nature of the installation, undercounter lavatories should be installed by trained and experienced installers.
- Do not use adhesives or adhesive sealants between marble countertop and lavatory.
- Inspect the waste and supply tubing; replace if necessary.
- Prior to installation, unpack the new lavatory and inspect it for damage. Return the lavatory to its protective carton until you are ready to install it.
- Observe all local plumbing and building codes.
- Kohler lavatory is made according to American National Standard that it can match the American lavatory fittings. Any other lavatory fittings may not fit for Kohler lavatory.
- Fixture dimensions are nominal and conform to tolerances established by ASME Standards (A112.19.2-2013).
- The product complies with GB/T 6952-2015.
- Please purchase 880089-CP as accessory to match with draw bar faucet of Kohler brand.

安装之前

- 有关安装专业性，故台下或脸盆必须由受过训练及有经验的技师进行安装。
- 切勿在脸盆与大理石之间使用密封胶或有黏性的密封胶。
- 检查出水及供水管道，如有需要便更换。
- 安装之前先开启新脸盆的包装，检查有无损坏后放回纸箱中以免损坏，到准备安装时才取用。
- 遵守当地所有给排水及建筑规定。
- 科勒洗脸盆是根据美国标准制造的，与美国式洗脸盆配件相配，其它洗脸盆配件可能与之不相配。
- 部件尺寸为标定值，误差符合美国ASME标准(A112.19.2-2013)。
- 本产品符合GB/T 6952-2015。
- 如匹配科勒提拉杆龙头，请另购买配件880089-CP，来配合安装。

INSTALL THE LAVATORY

- NOTE:** Install so future removal from underneath the countertop is possible to avoid damage to the countertop.
- Check the desired lavatory location for clearance between the backsplash, faucet, fixture, and cabinet.
 - Cut out the template.
 - Locate the installation position. Make sure the overflow hole is on the front of the countertop and the logo is on the faucet side.
 - Carefully position and trace the template on the countertop as directed on the template.
 - Mark the faucet hole centerline on the countertop.
 - Drill a 13mm pilot hole on the inside of the cut line.
 - Cut out the countertop opening with a saber or keyhole saw.

安装脸盆

- 注意：安装中更允许将来可以从盥洗台面之下进行拆装，以免台面损坏。
- 检查准备装上脸盆的位置，是否与防溅挡板、水龙头、脸盆及储物柜保持足够的距离。
 - 剪出模板。
 - 请确定产品安装位置，注意溢水孔位置在台面安装前端，商标位置在水龙头安装面一侧。
 - 将模板小心放置于台上，并在台面上按照模板画出其边缘轮廓导线。
 - 在盥洗台上标出水龙头孔位的中心线。
 - 在切线内侧钻出一个13毫米的导孔。
 - 用匙孔线锯或者手提电锯切开盥洗台面。

FOR WOOD COUNTERTOPS

- Mark and pre-drill the wood screw holes at the locations shown on the template.
- Waterproof any exposed areas of wood.

木制盥洗台面

- 按照模板所示的位置，在台面标出及预先钻木螺钉的孔位。
- 其它外露的木质表面需要保持防水。

FOR MARBLE COUNTERTOPS

- Clean the countertop and block. Keep them dry.

大理石盥洗台

- 清洁台面和定位块，并保持干燥。

TOOLS AND MATERIALS

- Sealant
- Pencil
- Tape measure
- Sharp knife or scissors
- Keyhole or saber saw
- Drill (13mm dia. drill bit or larger)
- Safety glasses
- Hammer
- Rags or paper toweling
- Strong AB sealant

所需的工具和物料

- 密封胶
- 软性铅笔
- 卷尺
- 尖刀或剪刀
- 匙孔线锯或手提电锯
- 钻(直径13毫米或者更大的钻头)
- 护眼镜
- 锤子
- 抹布或者纸质毛巾
- 高强度AB胶

NOTE: You may require different, more specialized tools to install this lavatory to countertop materials other than wood or wood composites.

注意：若盥洗台的物料并非木或木质合成品，则您可能需要在安装脸盆时使用其他更专业的工具。

ROUGHING-IN

Reference Value
参考值

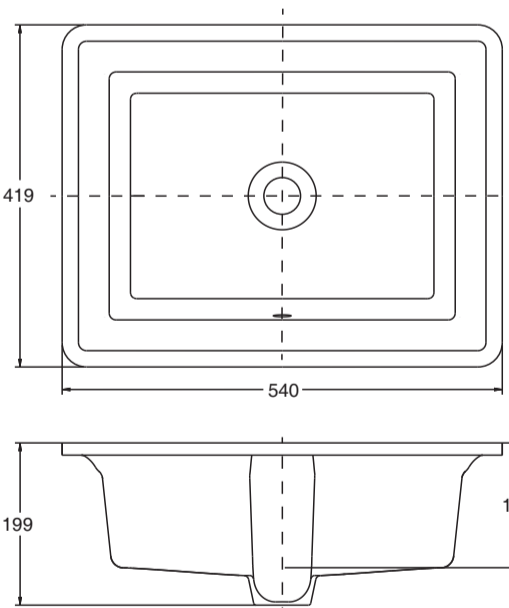

尺寸图

Unit: mm
单位: 毫米

	Length 长	Width 宽	Height 高	Depth 盆深
Outer 外尺寸	540	419	199	153
Inner 内尺寸	476	355		

Note: waterproof unprotected overhang area on the underside of wood counter.
注：木质盥洗台面板下突出部份须作防水处理。

Kohler reserves the right to change marked dimensions without prior notice.
科勒公司保留随时变更图中标示尺寸的权利，无需另行通知。

- Place the lavatory after 2 hours. Tighten the screw and apply silicone sealant around the edge of the lavatory.
- Keep away from heavy objects within 24 hours.

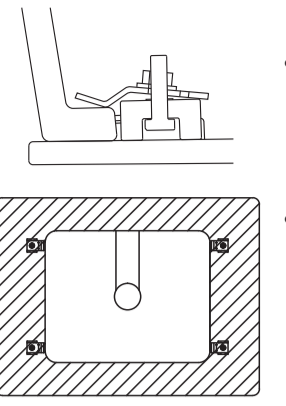

- 2小时后将盆放好，拧紧螺母，沿盆边打好密封胶。
- 24小时内勿承重物。

FOR ALL INSTALLATIONS

- If the countertop has not been installed, install it at this time.
- Drill the faucet holes according to the faucet installation instructions.
- Install the faucet to the countertop according to the manufacturer's instructions.
- Install the drain to the lavatory according to the manufacturer's instructions.

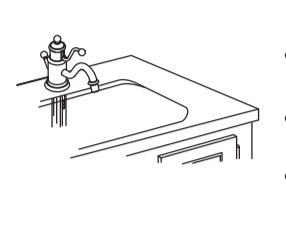

所有台面的安装

- 如还未安装盥洗台，请在这时装上。
- 按照龙头安装说明引钻龙头孔。
- 按照制造商的说明书，在盥洗台上装水龙头。
- 按照制造商的说明书，在脸盆下装上排水管。

NOTE: Please do not use sealant with contractility after drying, such as marble adhesive.

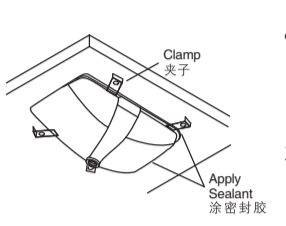

注意：请勿在本品上使用干燥后有收缩性的胶粘剂，如云石胶等。

- Apply a continuous bead of quality sealant to the lavatory rim where it will contact the countertop, such as glass cement.

- 在与盥洗台接触的脸盆边缘，如珠串般滴上优质密封胶，如玻璃胶等。

NOTE:

- For wooden countertop, use the clamp assembly supplied.
- For countertop made of wood or wood compound (over 25mm thick), purchase clamp assembly 52047.
- For countertop of other materials, use proper clamp assembly by referring to the suggestions on the installation instructions of the countertop manufacturer.

注意：

- 大理石材质的盥洗台，使用随附的夹子组件。
- 木、木质合成物的盥洗台(厚度25毫米以上)，可另行购买夹子组件52047。
- 其它材料制造的盥洗台，则请参考盥洗台制造商说明书上的建议，使用适当的扣件。

- Position the lavatory squarely under the cutout before tightening the clamps. Draw the lavatory rim up to the countertop until it is snug. **Do not overtighten.**
- Immediately wipe away any excess sealant.
- Make the final drain and faucet connection to complete the IMake the final drain and faucet connection to complete the lavatory installation. Be sure to follow all instructions packed with the drain and faucet.
- Clean up with a non-abrasive cleaner.

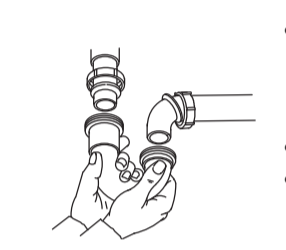

- 在上紧夹具前，先将脸盆平整地放在盥洗台切口下，然后小心将脸盆拉起直至合度才可上夹具，切勿上得太紧。
- 立即擦去多余的密封胶。
- 最后将所有水管及水龙头与脸盆连接妥当。确保安装乃符合水管及水龙头的一切有关的安装说明书。

IMPORTANT CONSUMER INFORMATION (CARE AND CLEANING)

- To keep your lavatory looking new, make sure you rinse it out thoroughly after each use. **DO NOT USE ABRASIVES** on this product, as they will scratch and ruin the surface. Stubborn stains, paint, or tar can be removed with turpentine or paint thinner.
- Do not use the product in the water below 0°C.
- Please do not use hard materials (like scouring pad) to clean product surface, especially the product logo.

用户须知 (护理和清洁)

- 为保持脸盆光洁如新，须确保每次使用后彻底冲洗干净，切勿使用磨蚀性的清洁剂，以免刮花及破坏脸盆的表面。要清除顽固污垢、油漆或柏油，可使用松油或油漆稀释剂。
- 不要在0°C以下的水环境中使用。
- 请勿使用钢丝球等硬质材料擦洗产品表面，特别是产品商标处。

FOR ARTIST EDITION PRODUCTS

Treat your decorative product just as you would treat your fine china. The best way to clean it is to use warm water and pat dry with a cotton cloth or soft sponge. **DO NOT** use bristle brushes or abrasive-backed sponges. They will scratch the decorative surface.

艺术陶瓷品使用及保养须知

请您像珍惜您的珍贵瓷器一样对待您的艺术系列产品，最佳清洗方式是使用温水擦洗，然后用棉布或软海绵轻轻拍干。请勿使用粗硬的刷子或带刮擦面的海绵，以免划伤装饰表面。

SERVICE PARTS

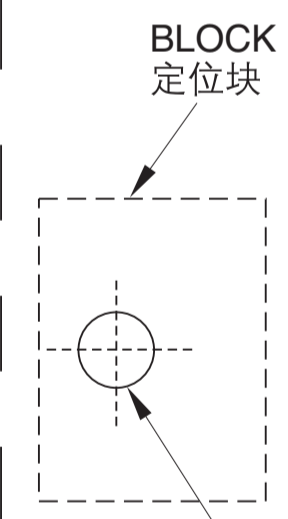

CLIP LOCATIONS 夹子位置

IMPORTANT:
For wooden countertop, basin clamp assembly 52047 purchased can only be used on countertops with a minimum thickness of 1". Installer must supply anchors for thinner countertops.

重要：
对于木质台面，另购的52047夹子组件仅可用于厚度最少为25mm的台面，如果台面较薄，请另外使用膨胀螺栓固定。

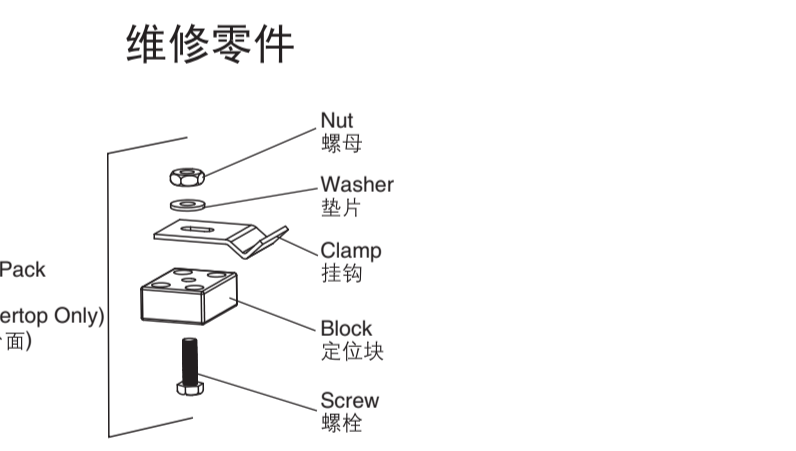

Note: Please purchase clamp accessory pack 52047 for wooden countertop. 注意：如为木质台面，请另行购买夹子组件52047。

Position of Overflow Hole
溢水孔位置在安装台面前端

No.2 KOHLER ROAD, SANSHUI CENTRAL INDUSTRIAL PARK, LEPING TOWN, SANSHUI DIST., FOSHAN, GUANGDONG, PRC POST CODE 528137
广东省佛山市三水区乐平镇三水中心工业园区科勒大道2号 邮编：528137

8# MENGSHAN RD, ECONOMIC DEVELOPMENT ZONE OF HUANTAI, ZIBO, SHANDONG, CHINA POST CODE: 256410
山东省淄博市桓台经济开发区蒙山路8号 邮编：256410

1354621-T01-B
© Copyright Kohler China Investment Co., Ltd. 2018
© 版权为科勒(中国)投资有限公司所有 2018